

# Basement

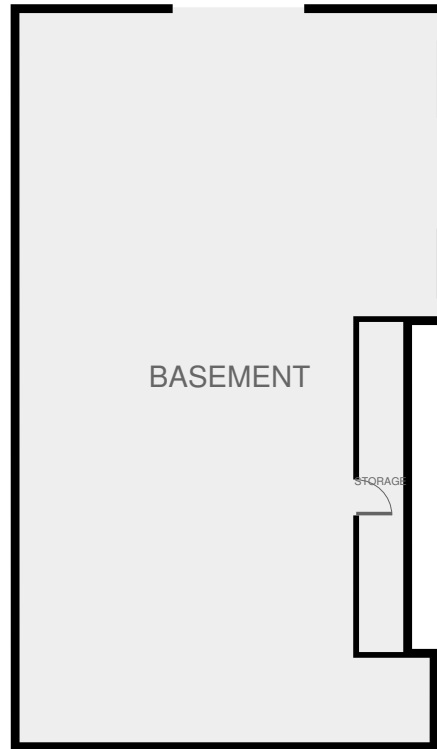

THIS FLOORPLAN IS PROVIDED WITHOUT WARRANTY OF ANY KIND. SENSOPIA DISCLAIMS ANY WARRANTY INCLUDING, WITHOUT LIMITATION, SATISFACTORY QUALITY OR ACCURACY OF DIMENSIONS.



## Farm House

108 Sullivan Drive, Dahlonega, GA, USA 30533

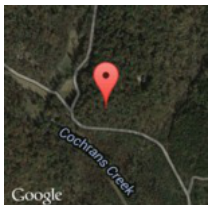

2014-03-17 16:18

**3642** sq ft  
**2** Floors  
**16** Rooms  
**3** Bedrooms  
**2** Bathrooms

# basement

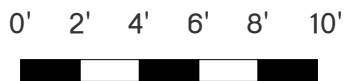
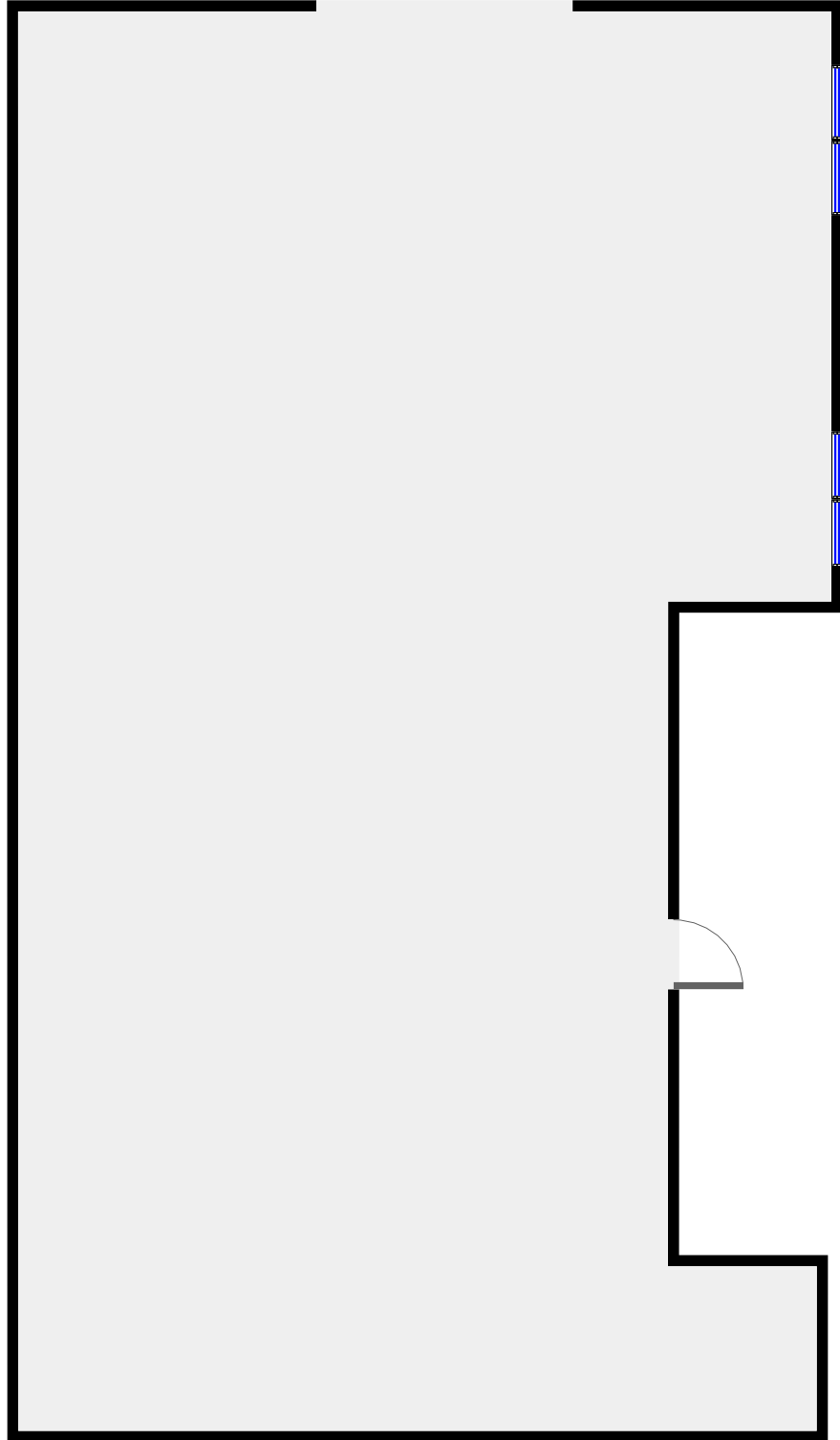
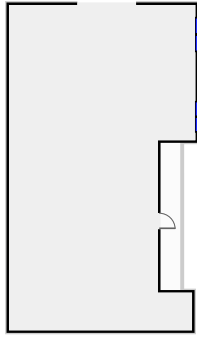

THIS FLOORPLAN IS PROVIDED WITHOUT WARRANTY OF ANY KIND. SENSOPIA DISCLAIMS ANY WARRANTY INCLUDING, WITHOUT LIMITATION, SATISFACTORY QUALITY OR ACCURACY OF DIMENSIONS.

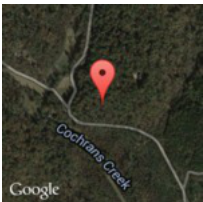

## Farm House

2014-03-17 16:18

# Storage

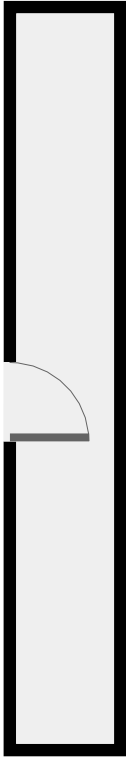
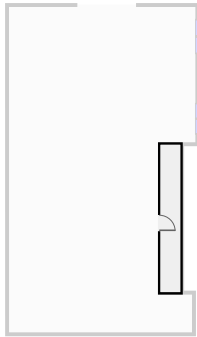

THIS FLOORPLAN IS PROVIDED WITHOUT WARRANTY OF ANY KIND. SENSOPIA DISCLAIMS ANY WARRANTY INCLUDING, WITHOUT LIMITATION, SATISFACTORY QUALITY OR ACCURACY OF DIMENSIONS.

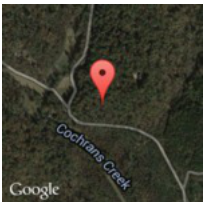

## Farm House

2014-03-17 16:18

# Ground Floor

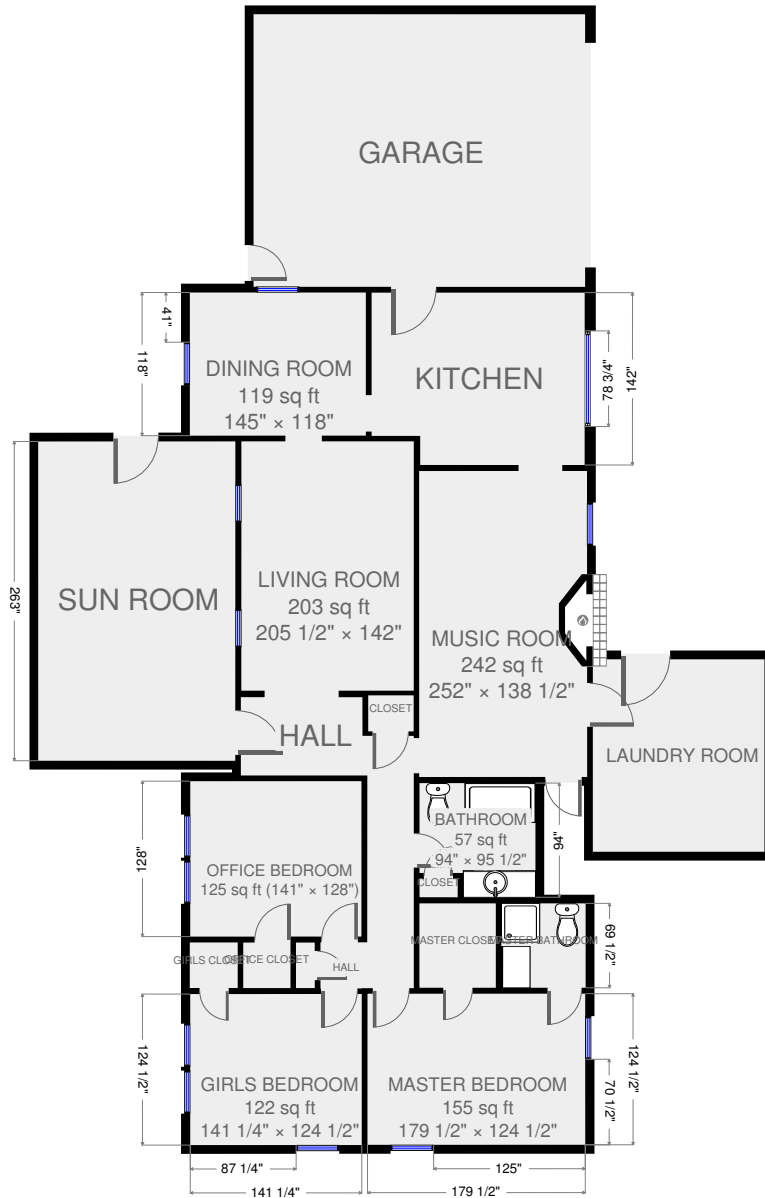

THIS FLOORPLAN IS PROVIDED WITHOUT WARRANTY OF ANY KIND. SENSOPIA DISCLAIMS ANY WARRANTY INCLUDING, WITHOUT LIMITATION, SATISFACTORY QUALITY OR ACCURACY OF DIMENSIONS.



## Farm House

108 Sullivan Drive, Dahlonega, GA, USA 30533

2014-03-17 16:18

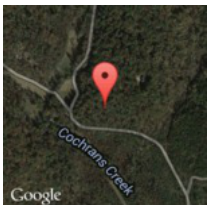

**3642** sq ft  
**2** Floors  
**16** Rooms  
**3** Bedrooms  
**2** Bathrooms

# Master Bathroom

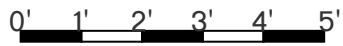
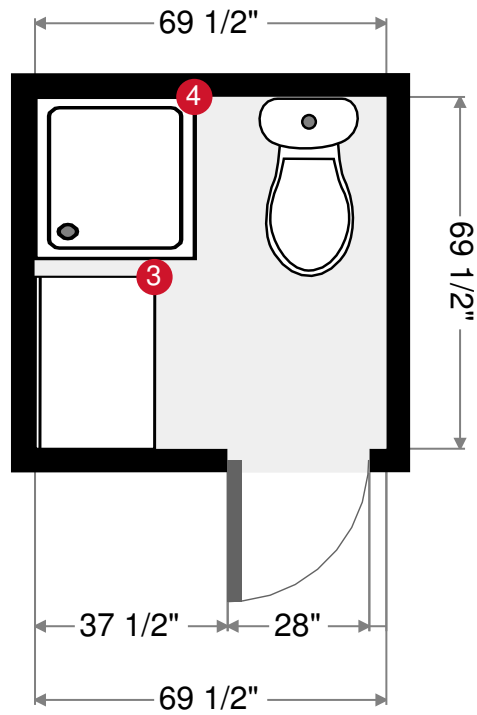
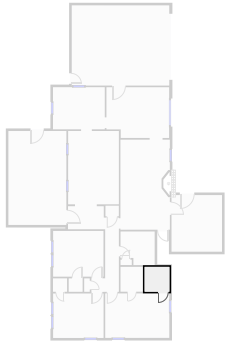

- |   |   |                    |   |
|---|---|--------------------|---|
| 3 |    | Vanity Cabinet     | - Width: 34"                                      |
| 4 |  | Rectangular Shower | - Width: 32"<br>- Depth: 31 1/2"<br>- Height: 80" |

THIS FLOORPLAN IS PROVIDED WITHOUT WARRANTY OF ANY KIND. SENSOPIA DISCLAIMS ANY WARRANTY, INCLUDING, WITHOUT LIMITATION, SATISFACTORY QUALITY OR ACCURACY OF DIMENSIONS.

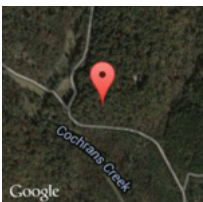

## Farm House

2014-03-17 16:18

# Office Closet

Width: 37 1/2"

Length: 39"

Area: 10 sq ft

Perimeter: 152 3/4"

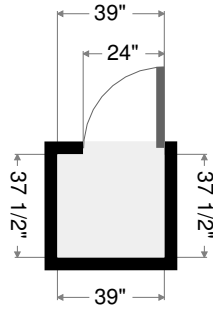
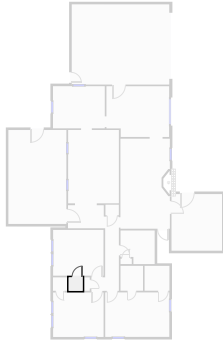

# Garage

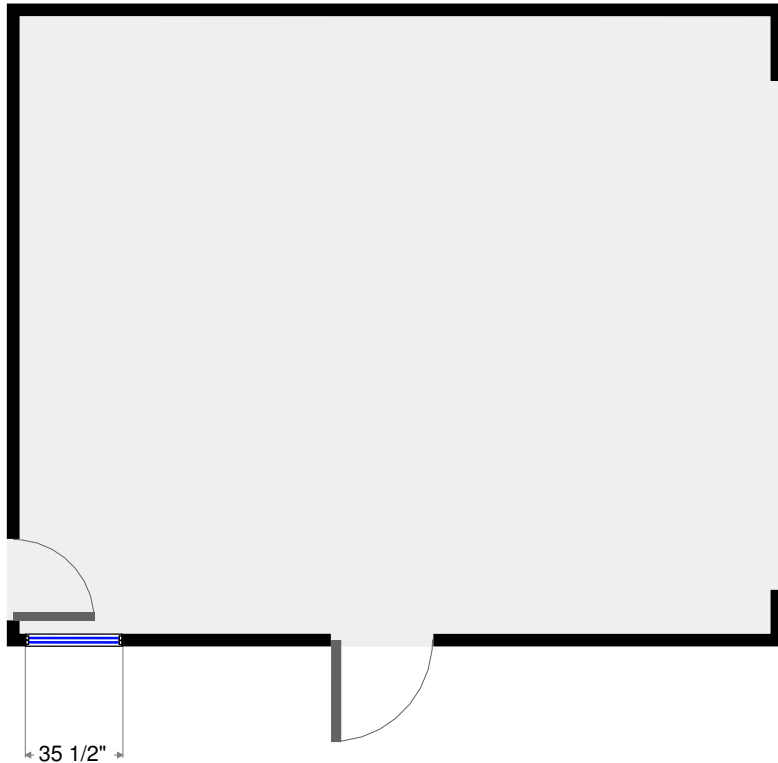
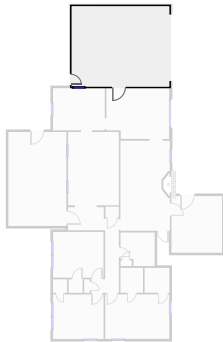

THIS FLOORPLAN IS PROVIDED WITHOUT WARRANTY OF ANY KIND. SENSOPIA DISCLAIMS ANY WARRANTY, INCLUDING, WITHOUT LIMITATION, SATISFACTORY QUALITY OR ACCURACY OF DIMENSIONS.

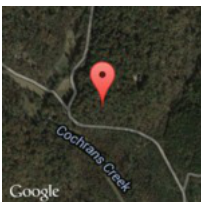

# Farm House

2014-03-17 16:18

# Laundry Room

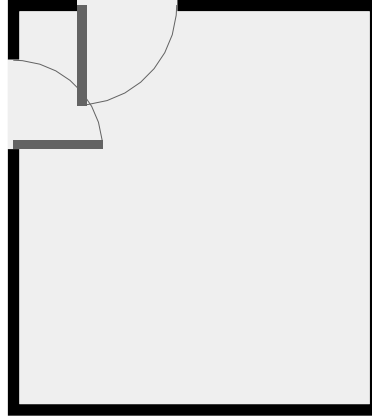
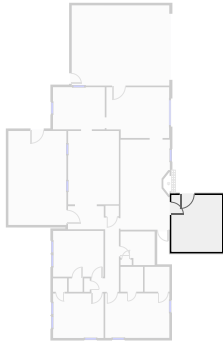

# Hall

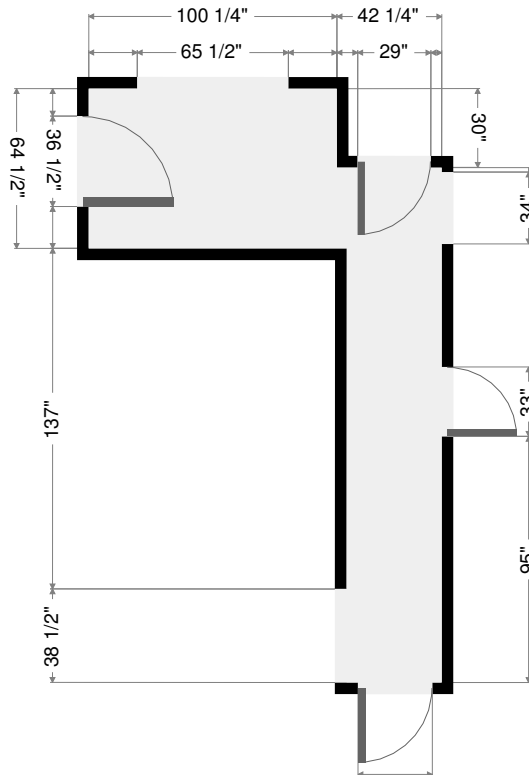
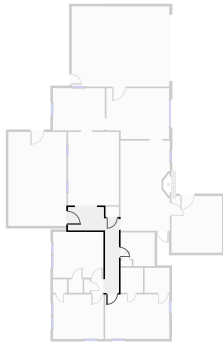

THIS FLOORPLAN IS PROVIDED WITHOUT WARRANTY OF ANY KIND. SENSOPIA DISCLAIMS ANY WARRANTY INCLUDING, WITHOUT LIMITATION, SATISFACTORY QUALITY OR ACCURACY OF DIMENSIONS.

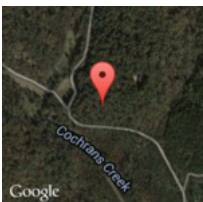

## Farm House

2014-03-17 16:18

# Hall Linen Closet

Width: 15 1/2"      Length: 37 1/2"  
 Area: 4 sq ft      Perimeter: 105 3/4"

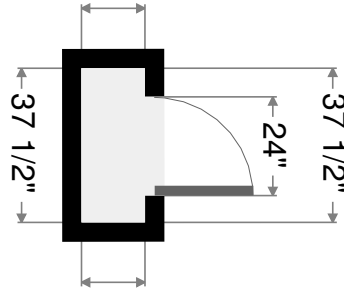
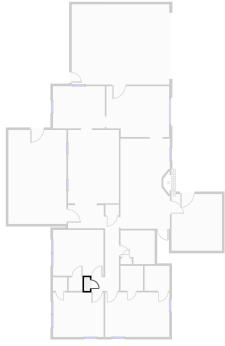

# Office Bedroom

Width: 128"      Length: 141"  
 Area: 125 sq ft      Perimeter: 538"

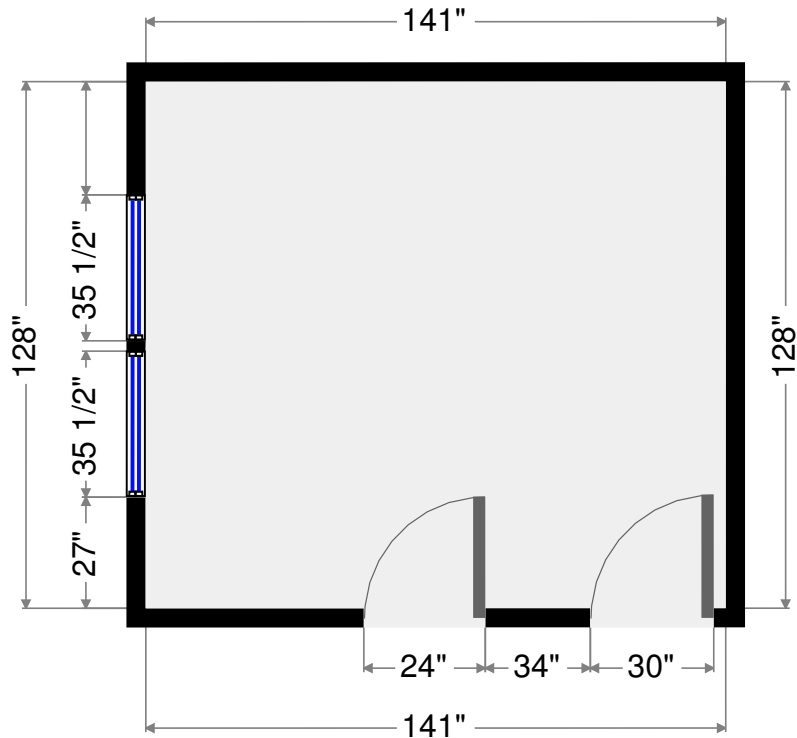
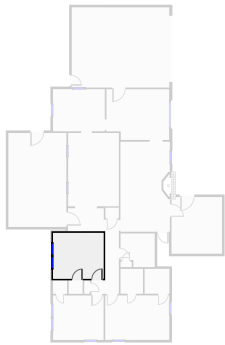

THIS FLOORPLAN IS PROVIDED WITHOUT WARRANTY OF ANY KIND. SENSOPIA DISCLAIMS ANY WARRANTY, INCLUDING, WITHOUT LIMITATION, SATISFACTORY QUALITY OR ACCURACY OF DIMENSIONS.

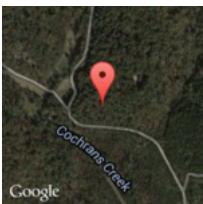

# Farm House

2014-03-17 16:18



# Girls Closet

Width: 37 1/2"      Length: 39 1/2"  
 Area: 10 sq ft      Perimeter: 153 3/4"

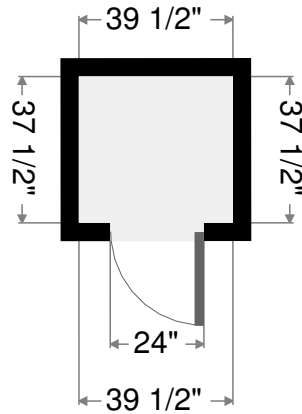
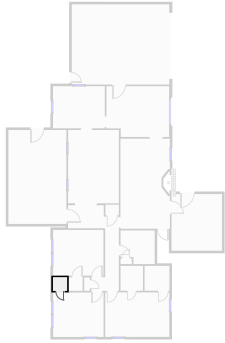

# Girls Bedroom

Width: 124 1/2"      Length: 141 1/4"  
 Area: 122 sq ft      Perimeter: 531 1/4"

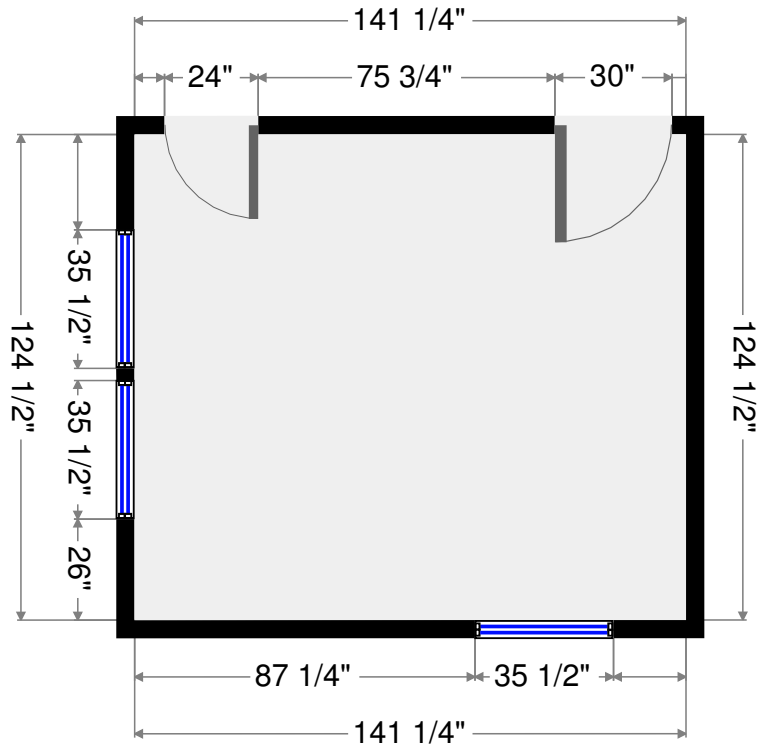
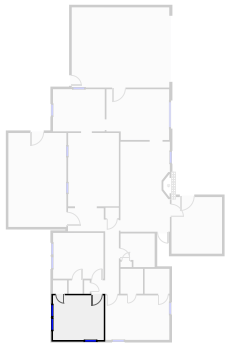

THIS FLOORPLAN IS PROVIDED WITHOUT WARRANTY OF ANY KIND. SENSOPIA DISCLAIMS ANY WARRANTY, INCLUDING, WITHOUT LIMITATION, SATISFACTORY QUALITY OR ACCURACY OF DIMENSIONS.

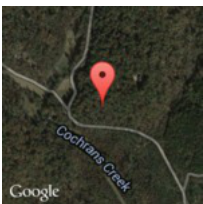

## Farm House

2014-03-17 16:18

# Hall

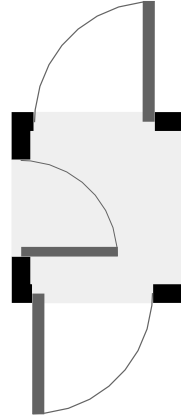
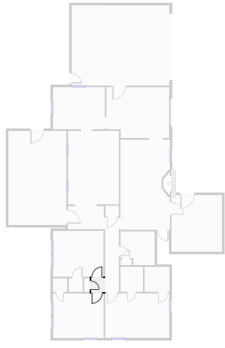

# Dining Room

Width: 118"      Length: 145"  
 Area: 119 sq ft      Perimeter: 525 3/4"

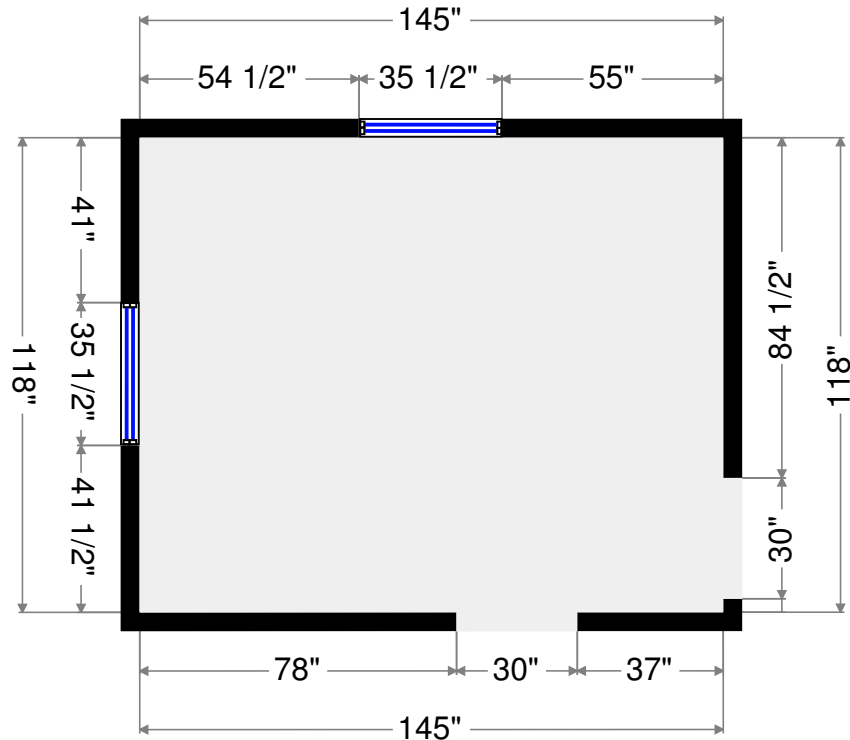
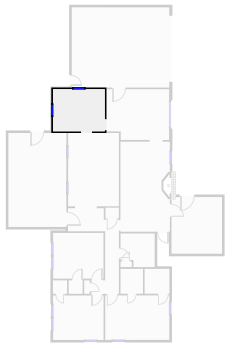

THIS FLOORPLAN IS PROVIDED WITHOUT WARRANTY OF ANY KIND. SENSOPIA DISCLAIMS ANY WARRANTY, INCLUDING, WITHOUT LIMITATION, SATISFACTORY QUALITY OR ACCURACY OF DIMENSIONS.

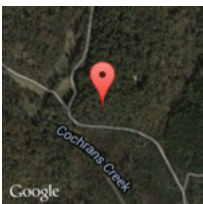

## Farm House

2014-03-17 16:18

# Closet

Width: 15"

Length: 31 1/2"

Area: 3 sq ft

Perimeter: 92 3/4"

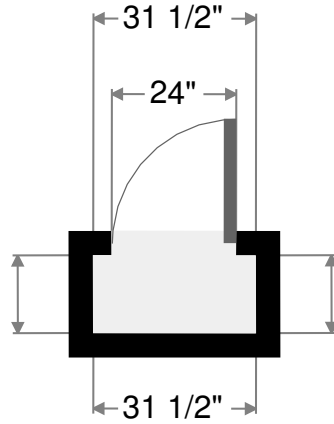
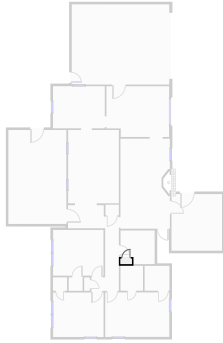

# Master Closet

Width: 63"

Length: 69 1/2"

Area: 30 sq ft

Perimeter: 265"

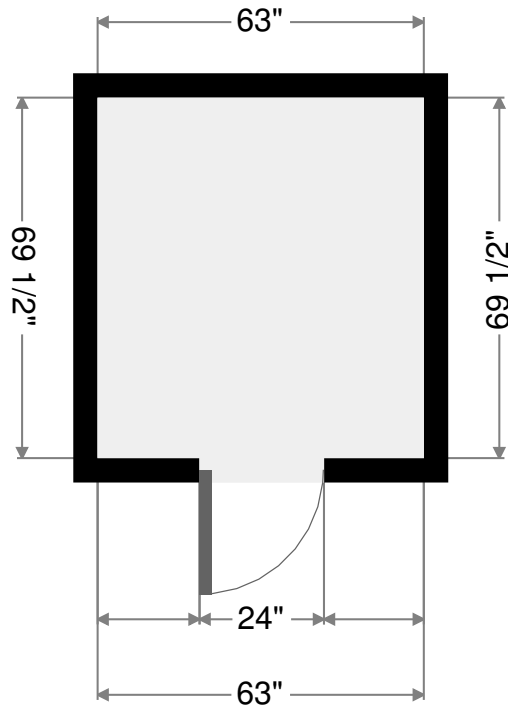
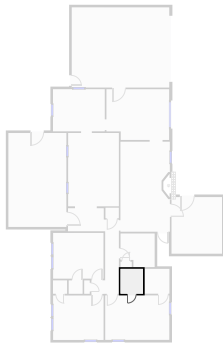

THIS FLOORPLAN IS PROVIDED WITHOUT WARRANTY OF ANY KIND. SENSOPIA DISCLAIMS ANY WARRANTY, INCLUDING, WITHOUT LIMITATION, SATISFACTORY QUALITY OR ACCURACY OF DIMENSIONS.

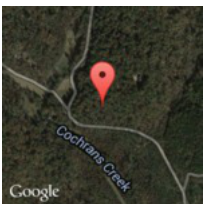

## Farm House

2014-03-17 16:18

# Master Bedroom

Width: 124 1/2" Length: 179 1/2"  
Area: 155 sq ft Perimeter: 607 1/2"

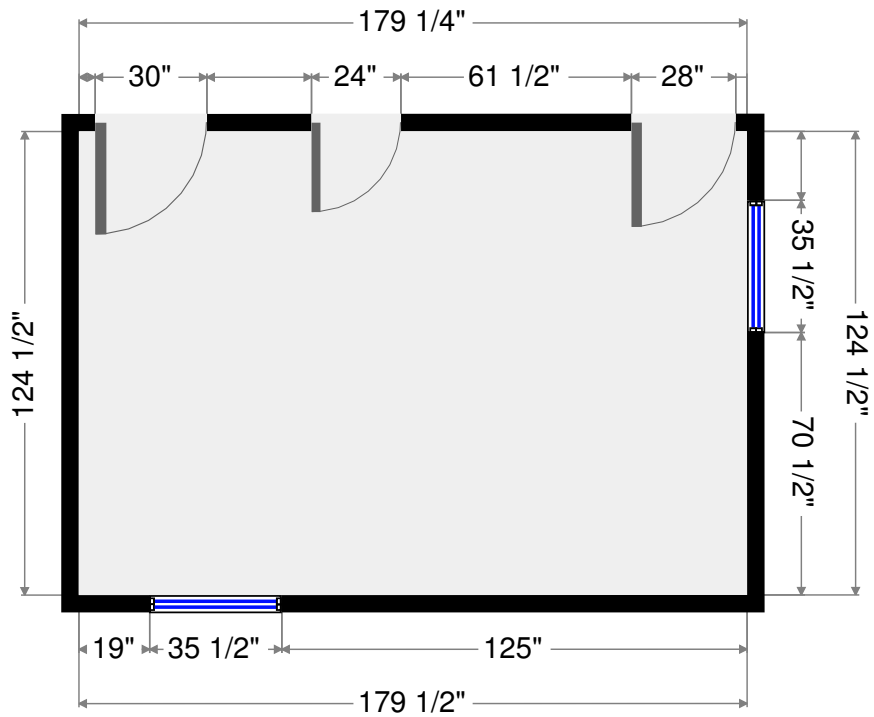
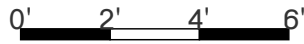
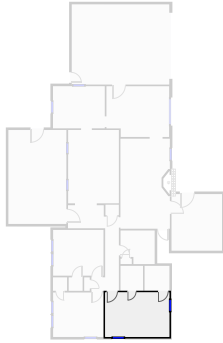

THIS FLOORPLAN IS PROVIDED WITHOUT WARRANTY OF ANY KIND. SENSOPIA DISCLAIMS ANY WARRANTY, INCLUDING, WITHOUT LIMITATION, SATISFACTORY QUALITY OR ACCURACY OF DIMENSIONS.

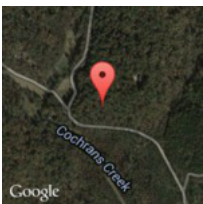

## Farm House

2014-03-17 16:18

# Bathroom

Width: 94"  
Area: 57 sq ft

Length: 95 1/2"  
Perimeter: 379"

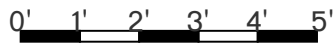
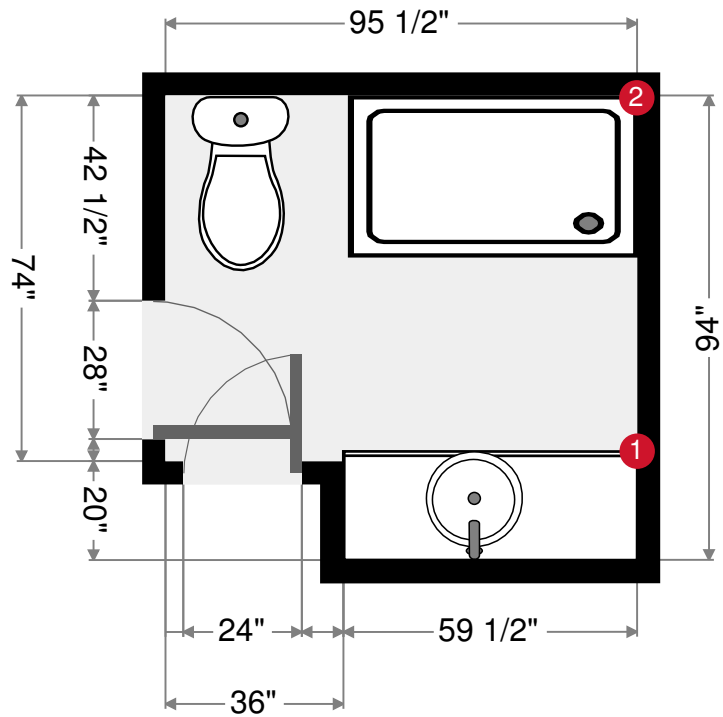
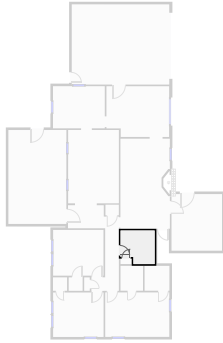

1



Vanity Cabinet

- Width: 59 1/2"

- Depth: 22"

2

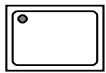

Rectangular Shower

- Width: 58"

- Depth: 32"

- Height: 72"

THIS FLOORPLAN IS PROVIDED WITHOUT WARRANTY OF ANY KIND. SENSOPIA DISCLAIMS ANY WARRANTY, INCLUDING, WITHOUT LIMITATION, SATISFACTORY QUALITY OR ACCURACY OF DIMENSIONS.

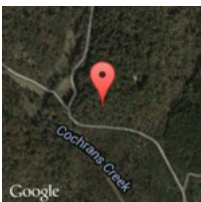

## Farm House

2014-03-17 16:18

# Closet

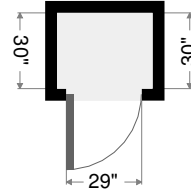
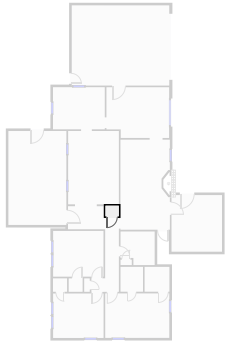

# Sun Room

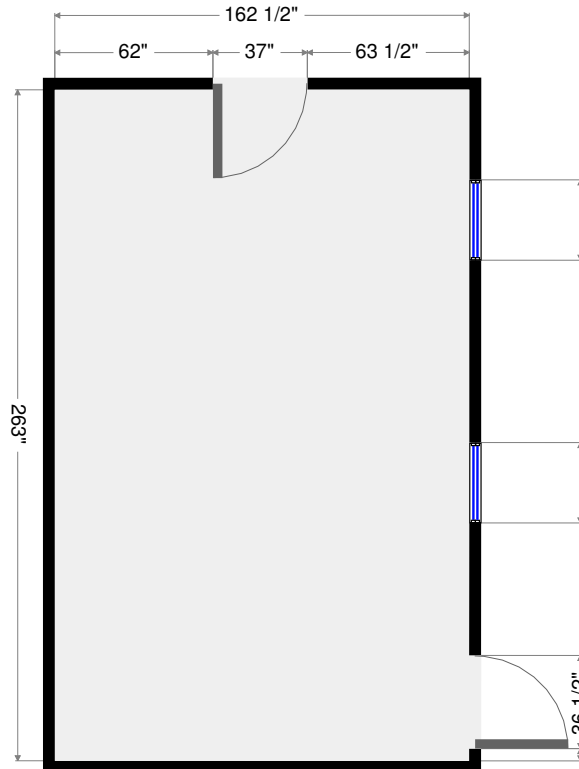
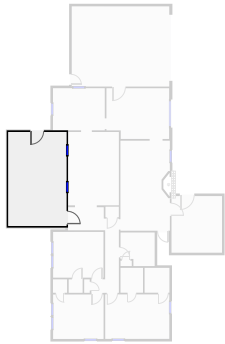

THIS FLOORPLAN IS PROVIDED WITHOUT WARRANTY OF ANY KIND. SENSOPIA DISCLAIMS ANY WARRANTY, INCLUDING, WITHOUT LIMITATION, SATISFACTORY QUALITY OR ACCURACY OF DIMENSIONS.

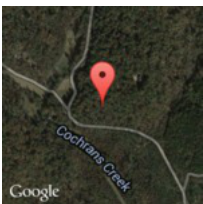

## Farm House

2014-03-17 16:18

# Music Room

Width: 138 1/2"      Length: 252"  
 Area: 242 sq ft      Perimeter: 780 3/4"

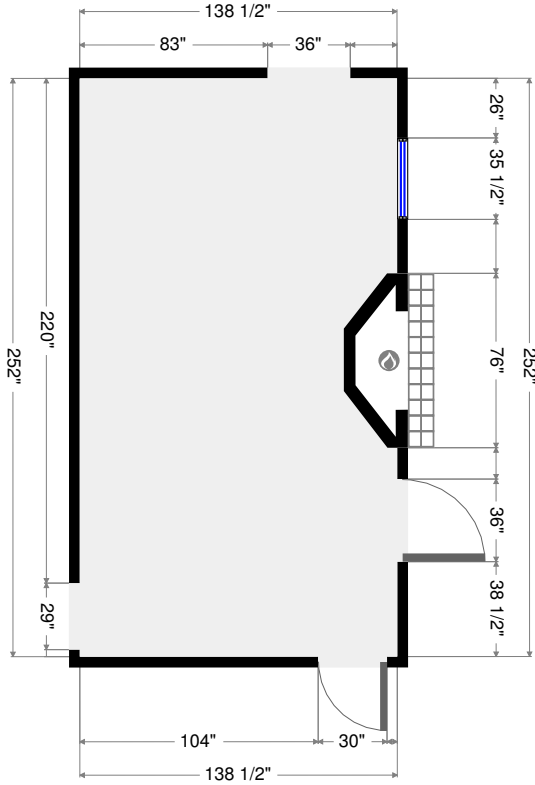
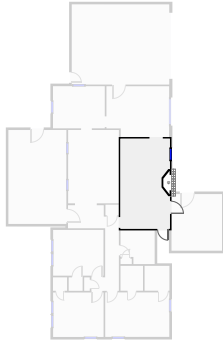

# Living Room

Width: 142"      Length: 205 1/2"  
 Area: 203 sq ft      Perimeter: 694 3/4"

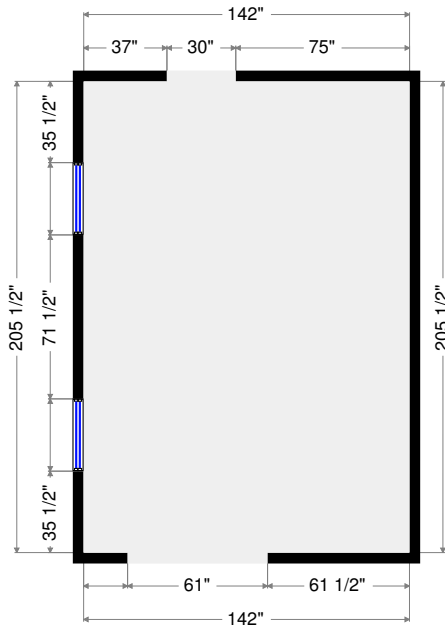
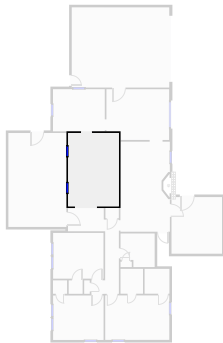

THIS FLOORPLAN IS PROVIDED WITHOUT WARRANTY OF ANY KIND. SENSOPIA DISCLAIMS ANY WARRANTY, INCLUDING, WITHOUT LIMITATION, SATISFACTORY QUALITY OR ACCURACY OF DIMENSIONS.

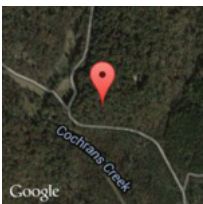

## Farm House

2014-03-17 16:18

# Kitchen

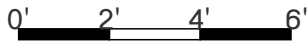
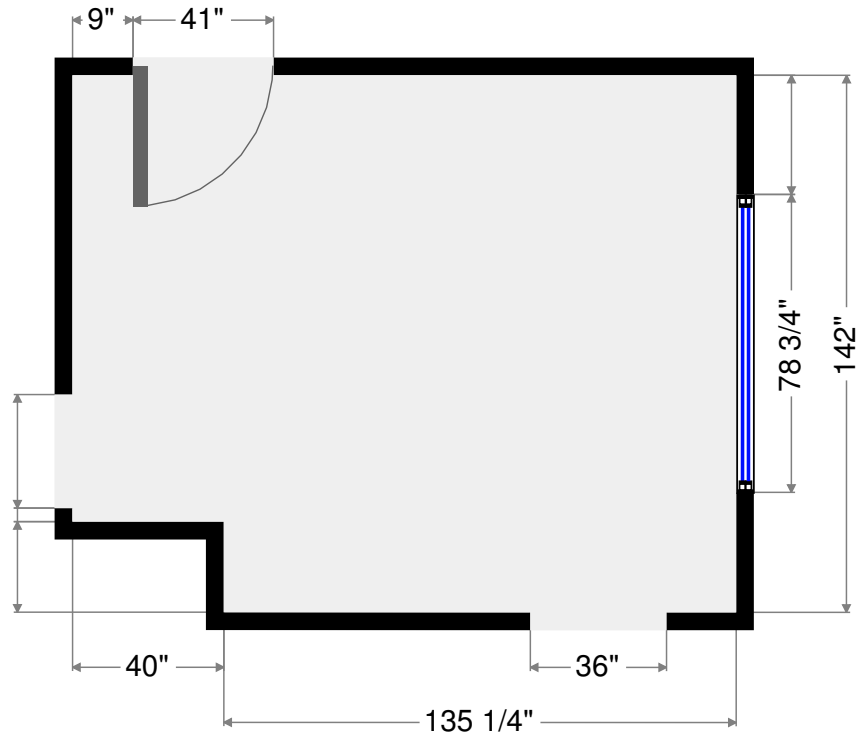
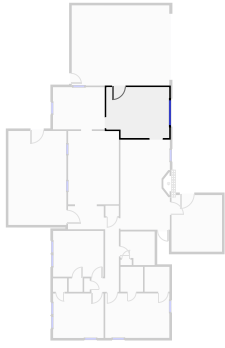

THIS FLOORPLAN IS PROVIDED WITHOUT WARRANTY OF ANY KIND. SENSOPIA DISCLAIMS ANY WARRANTY, INCLUDING, WITHOUT LIMITATION, SATISFACTORY QUALITY OR ACCURACY OF DIMENSIONS.

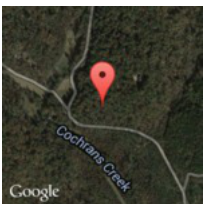

2014-03-17 16:18

## Farm House